

2015 Mapping Survey and Conservation Assessment of the USS *Macon* Site



Prepared by:

Megan Licklitter-Mundon
Nautical Archaeology Program
Texas A&M University

Bruce G. Terrell
National Programs Branch
Office of National Marine Sanctuaries, Maritime
Heritage Program

Michael L Brennan, Ph.D.
Director, Marine Archaeology and Maritime History
Ocean Exploration Trust

Robert V. Schwemmer
West Coast Region
NOAA, National Marine Sanctuary Program



**OCEAN
EXPLORATION
TRUST**



Contents

1. Project Title	3
2. Project Description.....	3
2.1 Research Objectives.....	3
2.2 Project Schedule	4
3. Archaeological Resource Management	4
3.1 Parties	4
3.2 Permitting	5
4. Historical Context.....	6
4.1 Discovery of the USS <i>Macon</i> and Previous Surveys.....	12
4.2 Current Site Description.....	16
5. 2015 Survey Methodology	18
5.1 Personnel	18
5.2 Technology.....	19
5.3 Site Mapping and Photomosaic	20
5.4 Image, Video of Specific Site Features.....	20
5.5 Excavation and Artifact Collection	21
5.6 Water Chemistry Data and Corrosion Readings	22
6. Artifact Conservation and Curation	23
6.1 Artifact Documentation and Conservation.....	23
6.2 Curation.....	24
7. Public Outreach, Educational Opportunities and Partnerships	24
8. Products	26
9. References Cited	27
Appendix A- Equipment Specifications.....	29
Appendix B- Artifact Conservation Budget	33

1. Project Title:

2015 Mapping Survey and Conservation Assessment of the USS *Macon* Site

2. Project Description

This project is to archaeologically survey the wreck site of the USS *Macon* airship, the US Navy's last *Akron*-class rigid airship. The project calls for documentation and small item recovery.

This project's primary goal is to provide ongoing stewardship of this wreck site by updating site documentation to supplement previous years' surveys. The Monterey Bay National Marine Sanctuary's (MBNMS) Final Management Plan (2008)¹ emphasizes the systematic assessment and monitoring of archaeological resources as a sanctuary priority. The USS *Macon* site contains some of the oldest known aviation material submerged in saltwater in the US. Since the discovery of the submerged remains of the Navy dirigible USS *Macon* in 1990, the National Oceanic and Atmospheric Administration (NOAA) and MBNMS have designated personnel to develop a program to document its archaeological resources through survey and sampling. The USS *Macon* site was assessed and deemed eligible for the National Register of Historic Places in 2006, and was listed in 2010.

The secondary goal is to study and benchmark site formation processes for an early modern-metals aviation site. Despite its age and marine organism activity, the metal and organic remains of the aircraft appear to retain a high level of integrity. A detailed study of the site formation processes, along with a sample comparison to 1991 sampled metal, will inform general archaeological knowledge of the potential longevity of aviation sites in deep water.

This survey's documentation methods will include creating an updated site map photomosaic, on-site photography and video, post-survey 3D modeling, and materials and samples study.

2.1 Research Objectives

The survey of the airship site is at the end of a longer, combined survey of Monterey Bay National Marine Sanctuary biological, natural, and archaeological sites. The USS *Macon* survey is expected to last 12 hours on the final day of the expedition, August 18th 2015. During that time objectives in order of priority are:

1. ROV Survey/ Orientation
2. Photomosaic Mapping
3. Biplane Mapping/Imagery
4. Limited Excavation
5. Sample Recovery

Secondary yet simultaneous goals are the live-feed outreach components described in section 7, which should be able to take place during the survey.

Post-survey processing of images, conservation of artifacts, and sample study are to be completed within the year.

¹ <http://montereybay.noaa.gov/intro/mp/mp.html>

2.2 Project Schedule

Fieldwork at the USS *Macon* wreck site will be conducted on August 18, 2015 for approximately 12 hours. More scheduling information will be available closer to the project date.

3. Archaeological Resource Management

The management of the remains of the USS *Macon* is shared by three different jurisdictions. The location of the wreck site off Point Sur coastline is within California State waters. It is also within the Monterey Bay National Marine Sanctuary. As a U.S. Navy craft, the airship and its aircraft are property of the U.S. Government.

3.1 Parties

The 2015 USS *Macon* survey is a joint-organizational project led by co-PIs from three of the stakeholder institutions in this project, NOAA, the Naval History & Heritage Command (NHHHC) and Ocean Exploration Trust (OET).

The Monterey Bay National Marine Sanctuary is a federally-protected marine area and is administered by NOAA under the Department of Commerce. Stretching from Marin to Cambria, the MBNMS encompasses a shoreline length of 276 miles and 5,322 square miles of ocean. The MBNMS was established for the purpose of resource protection, research, education, and to facilitate public use of its resources.

The National Marine Sanctuary Act (NMSA) mandates that the National Marine Sanctuaries manage and protect submerged archaeological sites within their boundaries. The sanctuaries are responsible for the identification and protection of submerged archaeological properties in their management regions as well as the development of education and outreach initiatives for those resources. The regulations pursuant to the NMSA direct the program to manage archaeological resources consistent with the laws and regulations of the Federal Archaeological Program (FAP) as administered by the National Park Service. Within the FAP, the National Historic Preservation Act of 1966 (as amended) directs federal programs managing public lands to survey and inventory historical and archaeological properties and assess them for their eligibility for the National Register of Historic Places. Within the National Marine Sanctuaries, these resources would include submerged prehistoric archaeological remains and historic shipwrecks and aircraft.

The sanctuary program collaborates with federal and state agencies, as well as the private sector, to document resources and to create opportunities to locate and record submerged archaeological resources. These studies provide a foundation for an inventory and enhance public awareness about the historic resources located in the sanctuary.

NOAA's Maritime Heritage Program (MHP), at the Office of National Marine Sanctuaries, Silver Spring, Maryland, coordinates maritime archaeological activities in support of the national marine sanctuaries. The MHP also provides technical assistance to the sanctuaries as well as state and other federal agencies.

US Navy ship and aircraft wrecks remain government property regardless of their location or the passage of time. All US Navy property, including the USS *Macon* wreck site, is protected from unauthorized disturbance under the Sunken Military Craft Act of 2005 (Public Law Number 108-375)²

The Navy oversees one of the largest collections of submerged cultural resources, which includes over 3,000 shipwrecks and 14,000 aircraft wrecks dispersed globally. In accordance with the Sunken Military Craft Act, NHHHC has established a permitting program, managed by the Underwater Archaeology Branch, to allow for archaeological, historical, or educational research on Navy's submerged cultural resources. The UAB also maintains the Archaeology & Conservation Laboratory for the stabilization, treatment, preservation, research, and curation of artifacts recovered from Navy sunken military craft.

Macon rests on California state bottomlands. The State Lands Commission and the Office of Historic Preservation work together when someone wants to study, excavate, or search for a shipwreck, which requires a permit. The Office of Historic Preservation reviews the permit applications and makes recommendations on site preservation and protection. If the application is satisfactory, the State Lands Commission issues the permit.

The relevant statutes are codified at California Public Resources Code §§ 6301, et seq., and the regulations are at California Code of Regulations Title 2 §§ 2002, et seq. and 14 §§ 929, et seq. These laws declare that California's archeological resources are endangered by development, increased population, and natural forces and that preservation of these resources is important to illuminate and increase public knowledge of the state's historic and prehistoric past.

3.2 Permitting

In preparing to comply with Article III.A.2 of the upcoming Interagency Agreement between the National Oceanic and Atmospheric Administration of the United States Department of Commerce and the United States Department of the Navy on Cooperation under the Sunken Military Craft Act (2015), NOAA has consulted with NHHHC in regards to recovering the sample from the site and its conservation and curation. As of August 7th, 2015, the agreement is not yet valid as the Final Rule upon which it is based has not been published.

Through inclusion of NHHHC as co-Principal Investigator in this project there is no permitting requirement on behalf of DON as it pertains to this project. NOAA and NHHHC remain liable for a research design and a final report.

NOAA will also consult with California State Lands Commission regarding all necessary permissions for the survey.

In compliance with Section 106 of the National Historic Preservation Act, Sec. 800:11, any site disturbance requires a formal review by California's Office of Historic Preservation prior to the undertaking. The MBNMS will seek concurrence with the California State Lands Commission regarding project goals and methodology.

² <http://www.history.navy.mil/research/underwater-archaeology/sunken-military-craft-act/ua-preservation-policy.html>

4. Historical Context

Development of Rigid Lighter-Than-Air Ships

France's Montgolfier brothers are most commonly attributed as the first successful lighter-than-air (LTA) inventors in 1783. Powered LTA flight was achieved in the late-nineteenth century by mating internal combustion engine-driven propellers with elongated balloons. The first true rigid airship is attributed to German Count Ferdinand Von Zeppelin whose name became synonymous with the type. Previous non-rigid airships were single envelope balloons filled with pressurized hydrogen lifting gas that carried its pilots and power source underneath. Semi-rigid airships had single gas envelopes attached to a rigid, usually metal, girder-built "keel" upon which propulsion and pilot stations were attached.

Von Zeppelin's contribution was to design a craft built of one or more longitudinal keels to which concentric vertical rings (also girder-built) were attached, much like the keel and frames of a ship. This construction allowed for a structure which housed several cells or bags which contained hydrogen as the lifting gas. The entire structure was covered in a skin which made it aerodynamic. The airships had controllable fins at the aft end. A control car was attached to the bottom, hanging outboard of the airships' frame. Engines were mounted externally and cabins, work areas and offices could be arranged internally on the keels.

The U.S. Navy's LTA Program

In 1915, the U.S. Navy's burgeoning aviation program first used LTA non-rigid ships for anti-submarine patrols along the U.S. Atlantic coastline. While several classes of blimp were built primarily at the Goodyear Company factory in Akron, Ohio, none were used overseas during America's participation in the First World War. In 1918 the Navy made a switch in lifting gas from flammable hydrogen to helium following the discovery of helium gas fields in Texas. While it provided slightly less lift than hydrogen, helium's non-flammability made it safer.

Soon after the end of World War I, the U.S. Navy began to explore the possible value of developing its own rigid airships. The first, named USS *Shenandoah* (ZR-1), was based on plans of a captured German airship but used American engines. Using materials shipped from Europe, its components were manufactured at the Naval Aircraft Factory at Philadelphia and assembled at the Naval Air Station (NAS) Lakehurst, New Jersey, where it was completed in 1922. It became a familiar sight in U.S. skies as it crossed the entire country visiting air shows and performing flyovers of American cities to promote the Navy's LTA program to the American people and politicians. The USS *Shenandoah* was lost in a disastrous crash over Ohio in a storm on September 3, 1925. One of the land owners at the present site and owner of an exhibit that includes artifacts from the crash, indicates that the Navy collected the remains of the airship and had them transported to an ALCOA facility and melted.

ZR-2 was built in England as the R-38 from a British design but never made it across the Atlantic. It crashed into the Humber River on August 23, 1921 killing its British crew and seventeen American officers and sailors (Grossnik 1987:24).

LZ-126 was delivered to the United States in 1926 in what was the first non-stop east to west flight by an aircraft between Europe and the American mainland. This airship was constructed as a result of World War I reparation agreements decreed by the 1921 Council of Ambassadors of the Allied Nations (Grossnick 1987:26). The ship was rechristened by Mrs. Calvin Coolidge on November 25, 1924 and was commissioned USS *Los Angeles* (ZR-3). *Los Angeles* proved to be the Navy's most long-lived and successful rigid airship, remaining on the Navy's list until October 1939. In 1929 *Los Angeles* was used to test the feasibility for operating heavier-than-air craft. It was fitted with a trapeze and at a cruising altitude of 2,500 feet and a speed of 48 knots, successfully captured and released an airplane that had a special hooking mechanism for landing. In 1931 *Los Angeles* participated in fleet exercises near the Panama Canal, scouting for the fleet. Although repeatedly "shot down," she proved her value by spotting "enemy" fleets before she was discovered and eliminated. Thus, a scouting mission for the new, larger airships was created (Grossnick 1987:27).

Between 1925 and 1933, Rear Admiral William A. Moffett was Chief of the Navy's Bureau of Aeronautics. Moffett was a champion of LTA flight potential for the Navy. In 1926 he prevailed upon Congress to provide funding for a more extensive airship program. H.R. 9690 created the Navy's "Five Year Aircraft Program" which included an authorization for two large rigid airships, the ZRS-4 and ZRS-5. In 1928, Goodyear-Zeppelin won a series of design competitions initiated by the Navy. The company signed a contract with the Navy for two rigid airships. ZRS-4 was to be delivered in thirty months and cost \$5,375,000 and ZRS-5 was to be delivered fifteen months after the first for a cost of \$2,450,000. (Smith 13-18) To facilitate the construction of the airships, Goodyear-Zeppelin completed the massive "Airdock" hangar (1,175 feet long by 325 feet wide by 211 feet high) at Akron which is still standing and is on the National Register of Historic Places (Millbrooke 1998).

The first built airship, ZRS- 4, was named the USS *Akron* in honor of the home of Goodyear's new airship factory. ZRS-5's name came as an act of political supplication. Georgia representative Carl Vinson was, at that time, the senior member of the House of Representatives' Naval Affairs Committee and so the airship was named *Macon* in honor of the largest city in his congressional district (Smith 1965:33, 95).

Akron-Class Airships

The *Akron*-class airships (so named because *Akron*, ZRS-4, was built first) were actually experimental prototypes for a planned class of ten larger "super" airships. As such they were the largest U.S. naval airships built to that time and were the first to carry aircraft in an internal hangar (Smith 1965:45). *Akron*-class airships contained a number of innovations which separated them from earlier German rigid airship designs, as well as being structurally more rigid than the German craft. Ten of the main circular frames were constructed from stiff duralumin "deep rings". The rings were built from riveted duralumin girders and were built in "pyramidal" sections as opposed to the German flat rings. These rings provided a stiff frame which did not require additional wire cable bracing like the German airships used, although the ZRS ships had a net-like web strung to prevent the gas bladders from pushing into an adjacent space. The *Akron*-class had rectangular-constructed longitudinal girders versus German triangular girders and the ZRS craft had three rigid keels while the German craft had a single bottom keel (Robinson 1982:179; Dick 1985:174-175). The three keels were arranged as an inverted triangle with the angles at the top and both sides. The arrangement allowed for open hangars along the bellies of the ships. The two lateral keels also permitted eight German Maybach engines to be mounted internally supported on the

two lateral keels. This was a first for airship design and it enhanced the crafts' aerodynamics (Smith 1965:179).

Inside the framing were twelve gas cells which held the helium lifting gas. Of various capacities, they were made of cotton cloth that was impregnated with a gelatin-latex compound to make them impervious to gas diffusion (oxygen leaking in, and helium leaking out). The cell composition was a departure from the previous airships which until then, had depended upon "goldbeater's skin" made from cow intestinal membranes. ZRS-4 used several of each type of cell, whereas *Macon* used all latex-impregnated cells (Smith 1965:196).

Controlling the airship's buoyancy was a constant balance of weight (ballast) and gas maintenance. There was a need to provide for the venting of gases in the case of emergency rapid ascent. Each bag had several 32in. diameter valves which were set to open when the internal cell gas pressure exceeded 1.7 inches of water (0.064 psi). Valves variously were either automatic or manual which could be controlled from the bridge (Smith 182, 196, 197).

The Project 1 design, from which *Akron* and *Macon* were derived, were designed to be outfitted with U.S.-built Packard engines. The Navy was not eager to rely on foreign-built power-plants, but the Packards proved unreliable compared to German-built Maybach engines which resulted in that company's selection. The twin-blade propellers were mounted on external brackets (*Macon's* design was ultimately changed to three-bladed props). Coupled to the engines by Allison transmissions, the propellers could be rotated three hundred and sixty degrees which enabled vertical takeoffs and landings. Gasoline for the engines was distributed through a system of 110 cylindrical tanks which were clustered around the eight engine rooms. The total fuel capacity was about 20,700 gallons or 126,000 pounds of gasoline (Smith 1965:193).

A feature unique to the *Akron*-class was the redesigned water recovery system, seen as external radiator-like condenser racks in sets of five that were positioned flush with the hull above each engine. The previous Navy airships had the systems built atop the external engines. The hot exhaust from the engines was directed up to the top of the condensers. The gasses broke down into water which was held in dedicated tanks to supplement ballast water that was dumped during take-off (Robinson 1982:179). The primary ballast water was kept in 44 fabric bags hung along the lateral keels (Smith 1965:193). One of *Macon's* improvements over *Akron* was that the engine-cooling radiators that were mounted on the propeller outriggers on *Akron*, were mounted flush against the hull with the condensers on *Macon* which resulted in a more aerodynamic shape and improved *Macon's* performance (Robinson 1982:186).

The single control cars were divided into three sections; a forward pilot house, adjacent to the chart room, and a smoking room abaft. A backup control cab with steering gear and windows was built into the forward end of the lower fin. The main control car housed the primary steering gear. The controls consisted of two control wheels, one mounted on the port side for the rudders and a forward wheel for the elevators. The steersmen were commanded by the captain, as was done onboard water-bound ships. The control car held eight engine-order telegraphs for communicating with the engine rooms. Finally, anti-aircraft machinegun emplacements were placed along the dorsal keel, the tail cone, the auxiliary control cab (lower fin) and the aft control car room (Robinson 1982:179).

The main living areas were inside the hull on either side of the aircraft hangar. Seven crew bunkrooms, heads, and the ship's power plant were all housed in the port side. The starboard side held the two officer's bunkrooms and contained several mess rooms for officers, chief petty officers and crew. Also, on that side were the propane-fueled galley, the generator room holding two Westinghouse 110volt generators and their 4-cylinder generators. The captain's cabin and the radio room were housed immediately above the control car which was forward of the hangar. In order to save weight, all furniture, desks, bunks, etc. were made of aluminum, most of them were securely attached to the deck (Smith 1965:195, 196).

The early tail fin designs for the *Akron* class followed the long, thin model of the German craft. However, to address complaints from airship pilot's that the lower fin was not visible from the control car during landing operations, the fins were shortened, deepened and widened. The modification reduced the four fins' attachment points along the main frames from three to two. The forward edge, also, no longer attached at a main frame but on a weaker, intermediate frame. This was believed to have had serious consequences for the *Macon* (Robinson 1982:179).

Heavier-than-Air Operations

The ability to carry aircraft expanded the scouting range of the airships and, subsequently, modified their mission from actual scout to base for the scout aircraft. Concept testing for aircraft launch and recovery began on the USS *Los Angeles* using a variety of biplanes in the 1920s. The dimensions of the T-shaped hangar door in the *Akron* and *Macon's* bellies determined the parameters of the airplanes that would ultimately compose the new airships' squadrons. The hangar doors could only accommodate an aircraft no longer than 24 feet with a wingspan no wider than 30 feet (Smith 1965:25).

The Curtiss F9C biplane did not fit the profile for a high performance aircraft with good all-around cockpit visibility, but it was superior to any likely competitors. While a call went out for pilots for a heavier-than-air squadron, the Navy placed an order with Curtiss-Wright for six aircraft. Following evaluation of the aircraft, the Navy ordered six operational craft to serve on the USS *Akron*, then being completed. Following the demise of the *Akron*, they were transferred to the *Macon*. The delivered F9C-2s were designated "Sparrowhawk" in keeping with the tradition of naming Curtiss fighters after hawks (ex. Hawk, Goshawk, Kittyhawk, etc.).

The Sparrowhawks were powered by Wright R-975-E3 power plants which generated 438 horsepower. Their maximum upper wing span measured 25' 5" and their length was 20' 7". They had an internal fuel capacity of 60 gallons and an external belly tank that could carry 30 gallons. They were equipped with two thirty-caliber machineguns mounted over the engine. Flight characteristics included a maximum speed of 200 mph (174 knots) with the undercarriage removed, a stall speed of 63 mph (55 knots), an initial climb rate of 1,700 feet per minute and a service ceiling of 19,200 feet. The aircraft had an operational radius of 176 miles and 255 miles with undercarriage removed and external fuel tanks in place (Smith 1965:185).

The biplanes had distinctive paint schemes from other contemporary naval aircraft. While they sported the standard high-visibility yellow top wing and gray fuselage, each plane in the Squadron exhibited its own designated color on a top wing chevron, engine cowl and wheel spats. The designated colors for each aircraft were:

9056 - Royal red

9057 – White

9058 - True Blue

9059 – Black
(Smith 1965:201-203)

9060 - Willow Green

9061 - Lemon Yellow

A single example of a Curtiss F9C-2 Sparrowhawk remains today. Sparrowhawk 9056 is presently in the National Air and Space Museum collection at the Udvar Hazy Center. Aircraft 9057 and the prototype XF9C-2 were both parted out to re-build 9056 for display. Aircraft 9058, 9059, 9060, and 9061 were on board the *Macon* at the time of its crash.

The technical process by which the airships recovered and launched aircraft was innovative. Because of the weight of the aircraft (2,770 pounds each), the airships took off without them. The planes then rendezvoused with the mother ship in the air. As the airship flew into the wind at approximately 80 knots (92 mph), with the retractable trapeze extended, the aircraft would approach from beneath. The aircrafts' "skyhook" had a guide bar that protected the propeller and served as a guide to the hook. Once the pilot captured the trapeze with the hook, a spring lock was automatically activated and the plane was secured. The airship crew, then winched down an arm holding a "saddle" that was attached at a pivot at the "elbow" of the trapeze end. The saddle stabilized the aft end of the aircraft so that it could be raised into the airship once the engine power was cut.

As each aircraft was lifted into the hangar bay, it was transferred to a monorail transport system that was arranged in an "x" pattern. This allowed four aircraft to be stored and maintained. A catwalk provided access for maintenance crew to service the planes. The landing gear were often removed and stored while auxiliary fuel tanks were attached to extend the aircrafts' range. All aircraft fueling was performed at a fixed auxiliary trapeze or "perch" set aft of the hangar and external of the hull (Miller 1995; Williamson [1930s]).

USS *Macon* (Figures 1-2)

Construction on the USS *Macon* began in October 1931 and it was christened just before the *Akron's* demise on March 11, 1933. *Macon* benefited from *Akron's* shakedown flights and four tons of dead weight were eliminated from *Macon*. It contained numerous modifications including three-bladed propellers which increased its speed as well as its fuel efficiency.

Under Cdr. Alger H. Dresel, *Macon* began extensive trials including hook-on tests with the Sparrowhawks, which had been transferred following *Akron's* crash. In October 1933, *Macon* made its first transcontinental cruise to its new base at Moffett Field in Sunnyvale, California.

During the year of *Macon's* operational phase, Lt. Harold "Min" Miller became her senior pilot. Miller was responsible for several innovations including the development of a radio homing process to allow the airplanes to go extend their scouting range "over the horizon." He also innovated the removal of the wheels while on board *Macon* and the adding of a 30 gallon belly tank which increased the Sparrowhawk's fuel capacity by 50%, again increasing their scouting range (Smith 1965:133).

During its first fleet exercises, *Macon's* performance during the fleet exercises was poor and she was repeatedly "shot down" by enemy cruisers and aircraft (Grossnick 1987:28-33). In July 1934, Lieutenant Herbert V. Wiley assumed command of the airship. A former executive officer on *Akron* and a veteran of both the airship service and the "blue water" Navy, Wiley was a flexible and insightful commander who realized the value of using the Sparrowhawks as scouts and of keeping *Macon* at a safe distance as

the aircrafts' base of operations. *Macon* continued to participate in fleet exercises and training for the next year during which time Cdr. Wiley's tactics began to show promise for the airship's future missions.

On the stormy night of February 11 - 12, 1935 *Macon* was returning to Moffett Field following a successful exercise over the Channel Islands. While over Point Sur, a gust of wind tore the upper tail fin away. The damage caused a loss of gas in the aft cells which forced a nose-high attitude. The crew's frantic dropping of ballast and heavy gear such as the radios caused the ship to quickly rise above its ultimate pressure altitude which caused gas vents to pop open and release more lifting gas. During the confusion, the crew also attempted to jettison the aircraft in the hangar bay with no success. *Macon* settled gently onto the surface of the ocean about three miles off the coast. All but two of the crew were saved by nearby Navy ships. *Macon* and its Sparrowhawks sank from sight. The subsequent inquiry focused on the upper tail fin which had been damaged ten months earlier. Witnesses included a light keeper at the Point Sur lighthouse who was observing the airship as the fin tore away (Grossnick 1987:32-33).

The loss of *Macon* lowered the curtain on the U.S. Navy's rigid airship program. The program had several prominent Navy champions for over fifteen years. Unfortunately, a combination of poor fleet exercise performances and too many high-profile LTA disasters ending with *Macon's* soured the Navy's high command (and Congress) on further expenditure of funds and other resources on rigid LTA craft. Additionally, aviation technology had advanced to the point that seaplanes could now fulfill the scouting mission. The Navy's Bureau of Aeronautics continued to promote plans for large "super airships" that were capable of carrying nine dive bombers but the lack of higher support prevented their moving off the design tables. While there was no official announcement that the rigid airship program was cancelled, the Navy ceased to ask for funding and the program died when the Goodyear-Zeppelin Corporation was dissolved on December 16, 1940 (Smith 1965:163-170).

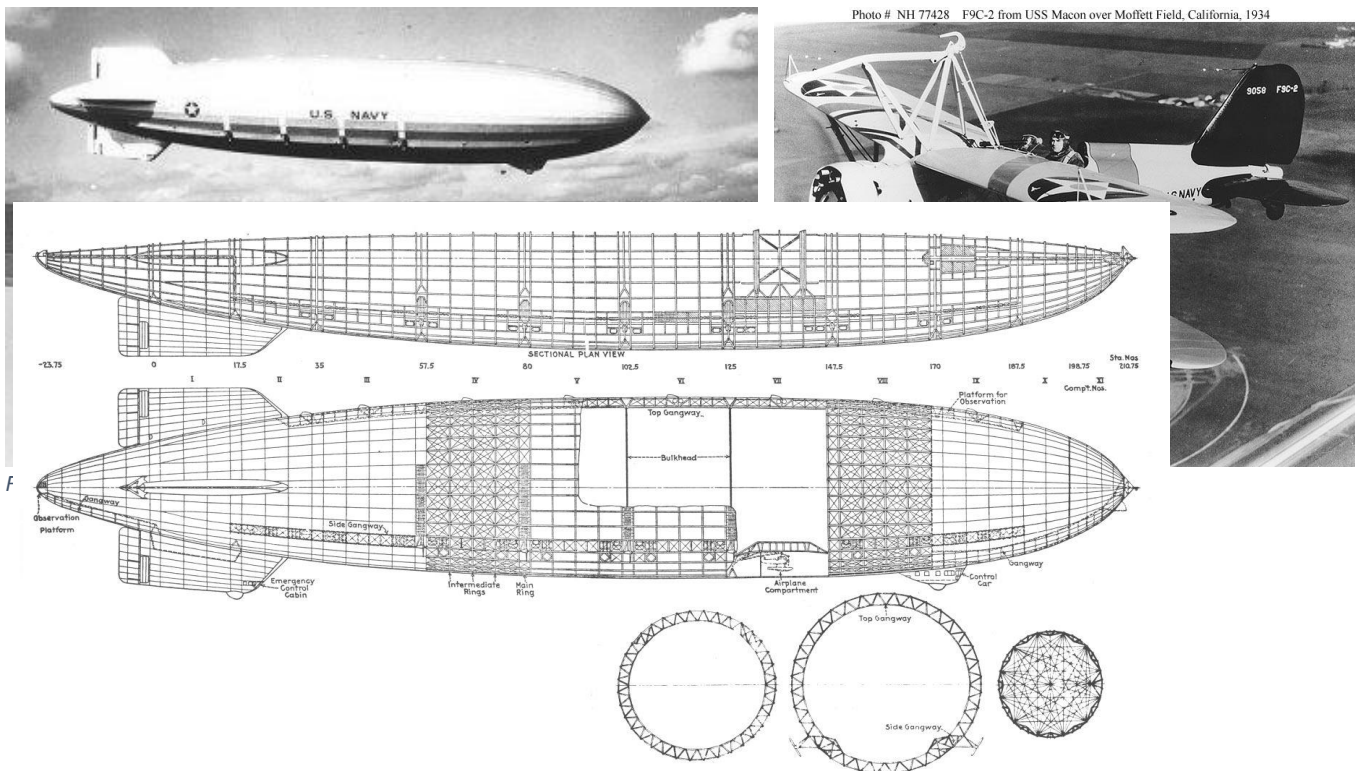

Figure 2- USS Macon line drawings. (NHHC)

4.1 Discovery of the USS *Macon* and Previous Surveys

Interest in locating the resting place of the *Macon* had been ongoing since 1988, when the first attempt to locate the *Macon* using sidescan technology proved that she was not lying at her recorded crash location. This initial effort had spawned the interests of Dick Sands of the National Museum of Naval Aviation Foundation in Pensacola, Florida as well as David Packard, founder of the Monterey Bay Aquarium Research Institute (MBARI). In 1990/1991 MBARI coordinated with the U.S. Navy to locate and document the *Macon's* remains at a depth of 1450 feet (442 meters). The first full color photomosaics of the biplanes (Figure 3) were taken showing an amazing level of preservation (Vaeth 1992). During these survey missions MBARI worked with the Navy to collect artifacts which included a steel trapeze hook from a Sparrowhawk (Figure 4). This steel artifact and two other aluminum artifacts were conserved at East Carolina University. Plans to raise one of the Sparrowhawks were considered but decided against by the Navy.

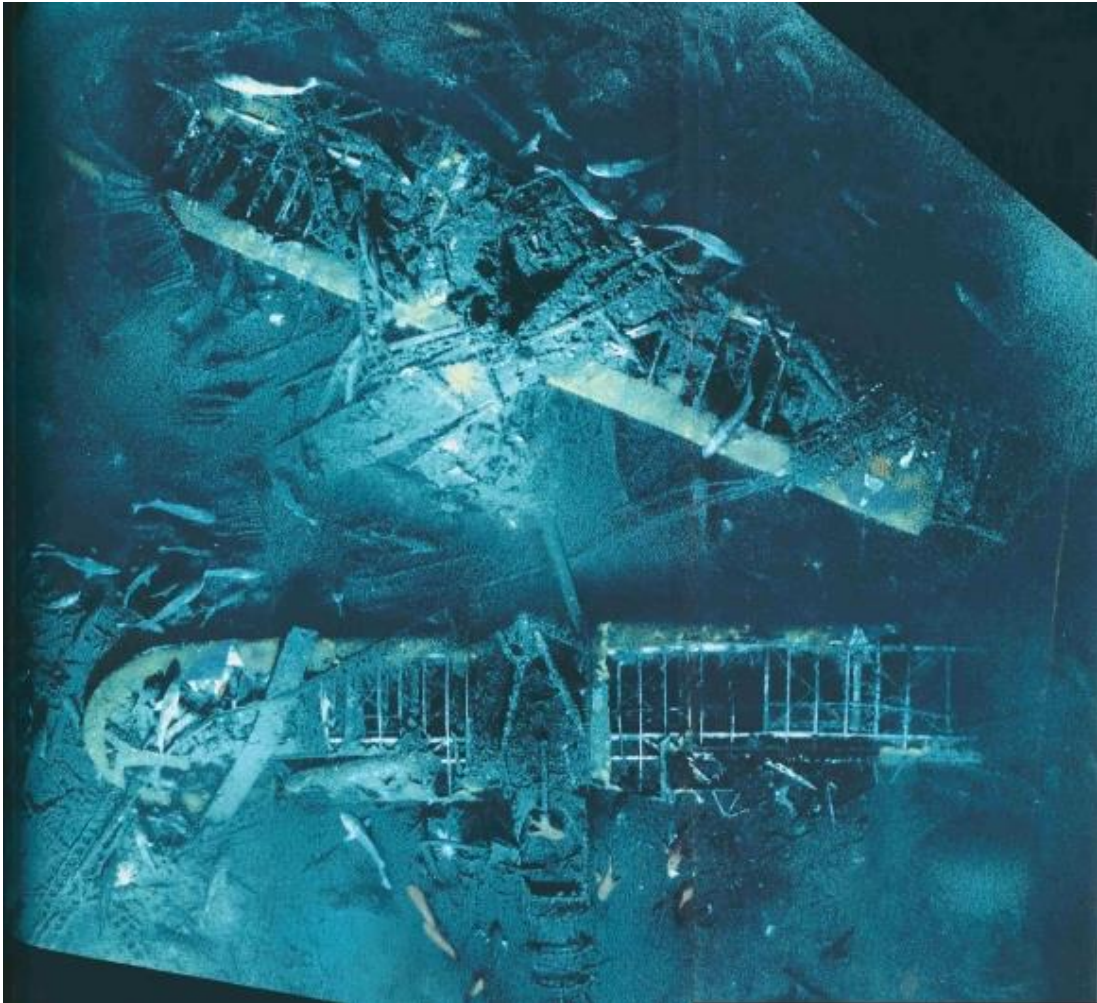

Figure 3- 1992 photomosaic of biplanes 1 and 2, Field A. (MBARI)



Figure 4- Recovery of the steel trapeze hook from the USS Macon site, 1991. (MBARI)

Fieldwork for the survey to establish *Macon* as a National Register Site was conducted over a four-day period on September 19-22, 2006 by NOAA and MBARI (Grech 2007). The first and foremost goal of the fieldwork was to systematically map, in photomosaic form, the visual remains of the airship and aircraft through high-definition video and high-resolution still photography (Figure 5). After the expedition, the imagery gathered was to be processed by the University of New Hampshire utilizing special software to create a photomosaic of the major debris fields (Figure 6). Following the expedition an analysis was conducted to compare the 2006 visual record to the site documentation in 1990/91. This provided comparative data on the rate of degradation of aluminum in a deep-sea saltwater environment (Grech 2007). The video from the 2006 expedition was also analyzed to identify several features and wreck components.

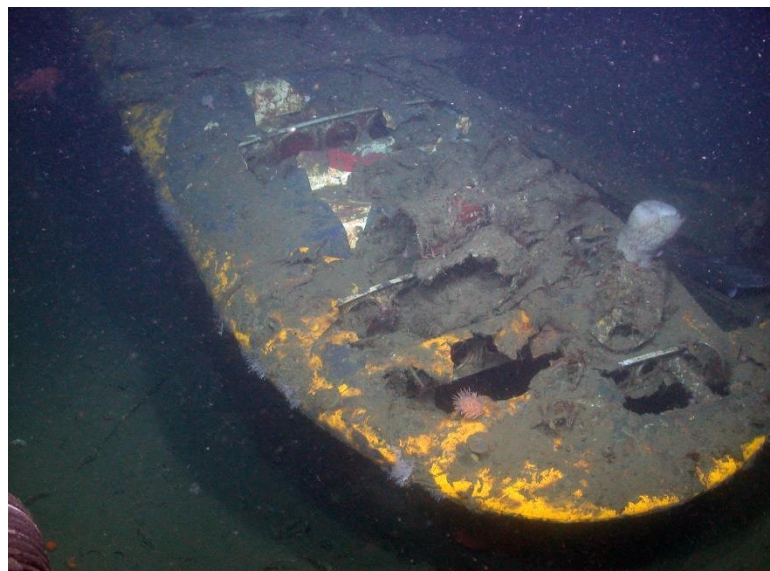

Figure 5- Image of the canvas cover an F9C-2 Sparrowhawk wing, which shows the colors of the Navy star insignia. (NOAA, MBARI)

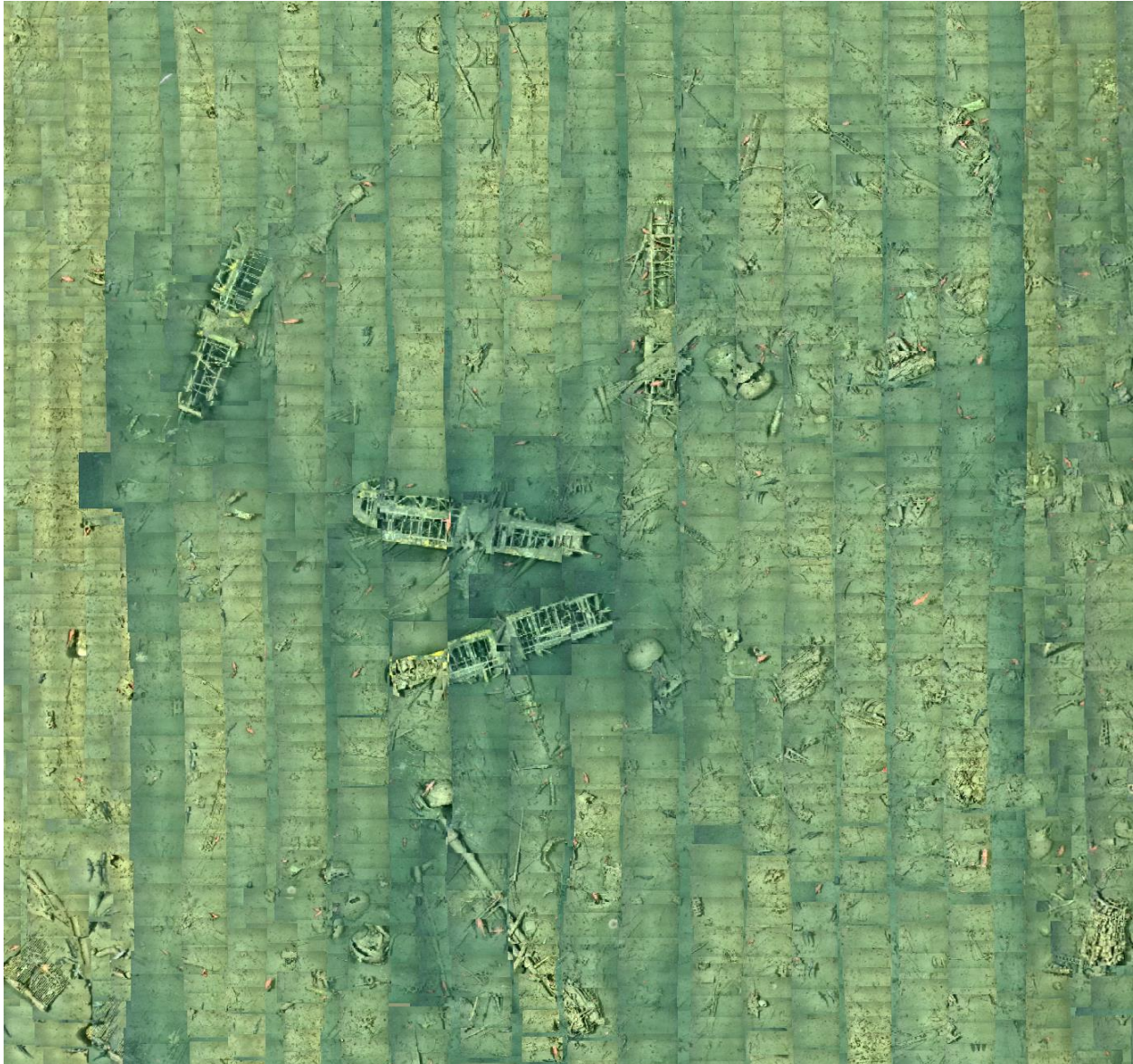

Figure 6- Photomosaic on USS Macon site in 2006. (NOAA, MBARI)

Both phases of the survey assisted in meeting the mandates of the National Historic Preservation Act which directs Federal programs managing public lands to survey and inventory historical and archaeological properties and nominate them to the National Register of Historic Places and the National Marine Sanctuaries Act which directs the MBNMS to manage and protect archaeological resources such as the *Macon* site. Using data acquired on the expedition, *Macon* was listed on the National Register of Historic Places in February 2010, 75 years after her loss.³

Between 2006 and 2015 comprehensive research was conducted to develop a contextual background of the USS *Macon* and the Navy's rigid airship program in the early 20th century. Research is ongoing to locate documents pertaining to the construction of airships as well as Curtis F9C-2 Sparrowhawk

³ For papers related to the nomination see http://www.nps.gov/nr/feature/weekly_features/2010/USSMacon.pdf

fighters. These records will aid archaeologists and historians in the identification of site features and will be used in education and outreach efforts. Regional museums and historical societies have also contributed towards the research effort, providing historic imagery and primary source documentation. The Monterey Maritime Museum, which has an exhibit on *Macon*, has assisted with research. The Moffett Field Historical Society, which is associated with interpreting *Macon's* hangar in Sunnyvale, California, was also involved in early project planning for the 2006 survey and provided framework examples for conservation study in 2014.

4.2 Current Site Description

The remains of *Macon* lie partially embedded in a sand bottom approximately seven miles south of Point Sur, California and approximately 3 nautical miles west of the coastline. It is located on submerged lands owned by the State of California within the boundary of NOAA's Monterey Bay National Marine Sanctuary. The site is in approximately 1500 feet of water.

Macon's wreckage is distributed into two discreet mounds, referred to as "Fields A and B" which are separated by a distance of 250 meters (820 feet) (Figures 7-8). The entire site encompasses approximately 5654.7 square meters (60867.19 square feet).

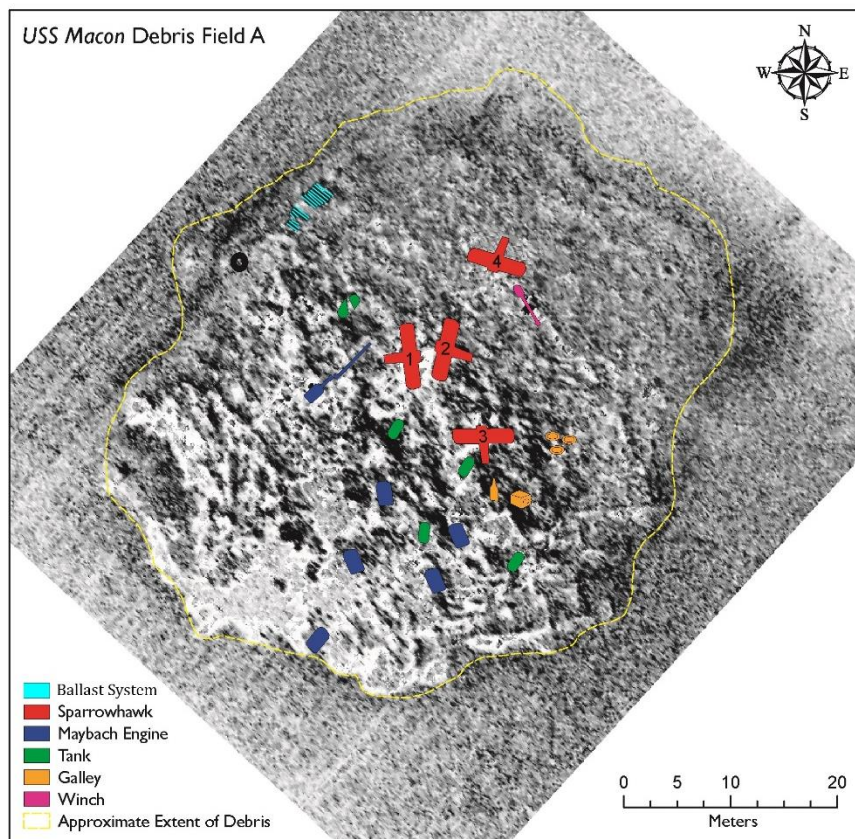

Figure 7- USS Macon Debris Field A. (NOAA)

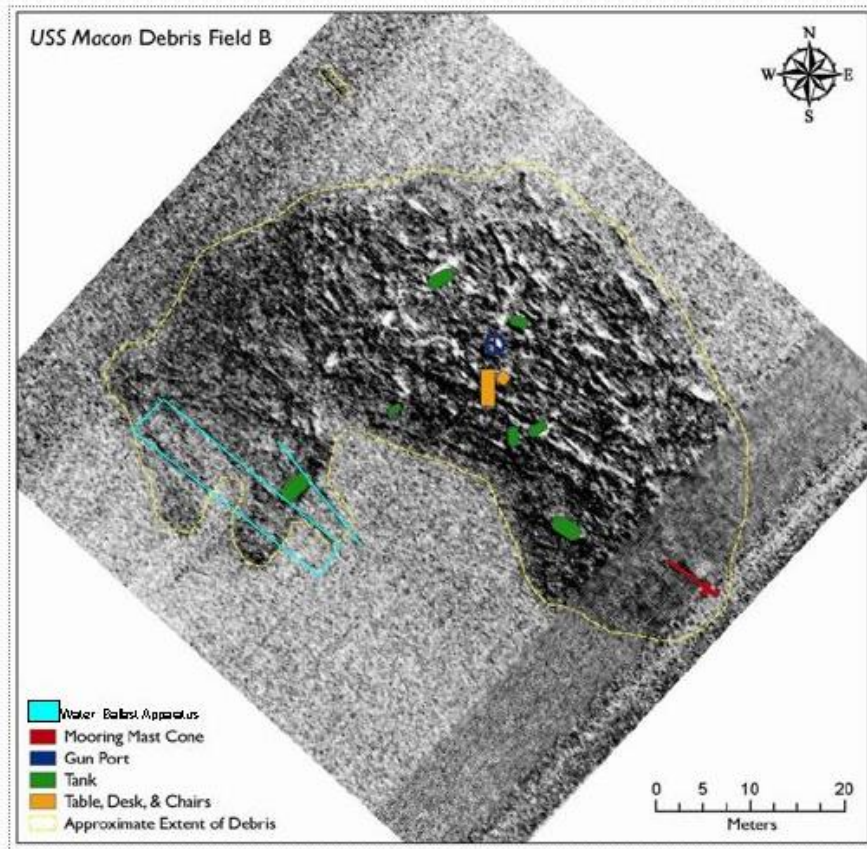

Figure 8- USS Macon Debris Field B. (NOAA)

Field A appears to contain the aft section of *Macon's* frame. The field of artifacts is distributed in a mound that is approximately 60 meters (196 feet) in diameter. The mound is elevated between three to five meters (10 to 16 feet) above the seabed. No test holes were dug but it is presumed that the mound constitutes the compacted wreckage of the aft section of *Macon* since there are no apparent geological "mound" formations in the vicinity of the wreck site that might suggest the site is resting on a geological formation.

Field A contains material that apparently relates to the crew and officers' galley (table, chairs, propane tanks, stove), airship propulsion systems (including five of the ship's eight Maybach VL-2 engines, one Allison propeller out-drive, fuel tanks and the engine water recovery system to replenish ballast water) and the aircraft hangar, which contained the four Curtiss F9C-2 Sparrowhawks (Bu No. 9058, 9059, 9060 and 9061).

The F-9C-2 Sparrowhawks all remain upright and in variable, yet above fair condition. Individual identification using video from previous years' surveys has not been possible, so the aircraft are numbered 1-4. The skyhook apparatus recovered in 1991 was from aircraft 3.

Lying approximately 250 meters (820 feet) from Field A, Field B is likewise about 60 meters in diameter, although it is arrayed in an arc with its lobes oriented east and west. This mound, too, is elevated from 3 to 5 meters (10 to 16 feet) above the seabed. Field B contains material that apparently relates to *Macon's* bow section. It includes the bow mast mooring receptacle assembly, another engine water

recovery condenser rack and furniture and materials possibly associated with meteorological or radio offices.

Both fields contained fuel and water tanks and *Macon's* duraluminum box girders, which showed marginal signs of degradation after 70 years in the marine environment. Comparisons with the 1990/91 expeditions indicate that several centimeters of sediment had built up on the site by 2006, and it also appeared that the site has not been disturbed by either fishing or looting in the interim (ONMS). The 2006 expedition did note some unexplained movement of artifacts especially surrounding or on top of the aircraft (Grech 2007).

5. 2015 Survey Methodology

In accordance with the MBNMS Final Management Plan (2008), this survey's primary goal is to provide ongoing stewardship of this wreck site by updating site documentation to supplement previous years' surveys. This will be achieved with the updated site map photomosaic, on-site photography and video, post-survey 3D modeling, and materials and samples study. From this data researchers will be able to track the USS *Macon's* state of preservation and document the extent of her debris field. Sampling and conservation of an artifact from the wreck site will allow research into the deterioration of the aluminum used as well as research into site formation and aluminum conservation processes. Public presentations and other outreach products will enhance public awareness of the USS *Macon's* role in the United States' military and aviation history as well as the Monterey Bay National Marine Sanctuary's management of its maritime heritage resources.

The USS *Macon* Expedition encompasses several facets, which include documentation, sampling, and small item recovery. Site assessment will consist of documenting diagnostic features of the multiple component wreck site (airship and aircraft remains).

The technical component involves video and photo documentation of the physical remains of the airship and four aircraft. An outreach component will include the hosting of a live web uplink during the operations to educate the community about the deep water technology used to conduct and archaeological survey as well as the sanctuary's management of maritime heritage resources.

5.1 Personnel

The project is led by several co-PIs from stakeholder organizations. A short description of roles and qualifications is given here and full qualifications are available by emailing bruce.terrell@noaa.gov.

Bruce Terrell, NOAA – Bruce is from NOAA's Office of National Marine Sanctuaries, Maritime Heritage Program. He will be coordinating efforts and overseeing the *Macon* survey from Silver Spring.

Bruce Terrell is the Chief Maritime Historian and Archaeologist for NOAA's Office of National Marine Sanctuaries, Maritime Heritage Program. His responsibilities include assisting with the initiation of resource inventory, and management and interpretation of the broad range of unique cultural maritime heritage resources in each of the sanctuaries. He also provides technical assistance to headquarters and field personnel on issues involving submerged archaeological sites and cultural properties within the sanctuaries.

Megan Licklitter-Mundon, NOAA – Megan will be aboard the E/V *Nautilus* helping direct survey efforts and operations.

Megan Licklitter-Mundon is an archaeologist and museum professional with a broad range of experience in the heritage sector. During the course of her archaeological career, Megan has directed or participated in terrestrial and underwater projects in the US, UK, Mediterranean, and the South Pacific. Prior to returning to graduate studies for her PhD she was the director of a local aviation history museum housed in a historic air terminal. She volunteers for and has served on the board of several non-profit museum organizations and is dedicated to museum development. Her studies with the Nautical Archaeology Program at Texas A&M University specialize in deep water and aviation archaeology, conservation studies, museum studies, and heritage preservation.

Michael Brennan, Joint NOAA/OET – Dr. Brennan will be aboard the E/V *Nautilus*, facilitating operations and the survey schedule.

Mike Brennan is the Director of Marine Archaeology and Maritime History for OET and Expedition Leader for *Nautilus*. Mike's research focuses on environmental assessments of shipwreck sites ranging from ancient to World War II. His past work has focused on documenting the extent and intensity of bottom trawl fishing damage to ancient shipwreck sites in the Black and Aegean Seas. Mike has been working on expeditions since 2006 and with *Nautilus* since 2009.

Mike Brennan graduated from Bowdoin College in 2004 with a degree in archaeology and geology, completed his MA in archaeology from the University of Rhode Island in 2008, and his PhD in geological oceanography at URI's Graduate School of Oceanography in 2012.

Alexis Catsambis, NHHHC – The US Navy will be represented by Dr. Alexis Catsambis from the Naval History and Heritage Command, Underwater Archaeology Branch. Alexis is a nautical archaeologist and cultural resource manager who provide for the stewardship, research, conservation, and curation of the U.S. Navy's submerged cultural resources. He received his PhD from Texas A&M's Nautical Archaeology Program in 2012.

Robert Schwemmer, NOAA - Robert Schwemmer is currently the West Coast Regional Maritime Heritage Coordinator for NOAA-Office of National Marine Sanctuaries. He coordinates and conducts archaeological surveys and research for the five National Marine Sanctuaries located along the Pacific West Coast. This work includes recording and mapping submerged sites utilizing SCUBA equipment, submersibles and remotely operated vehicles (ROV). Deep-water projects include working from a submersible to perform a site assessment of the shipwreck *Montebello*, a WWII era oil tanker located at a depth of 900 feet off Cambria, CA.

5.2 Technology

Photomosaic and microbathymetric mapping will be conducted from Exploration Vessel (E/V) *Nautilus* and ROVs *Hercules* and *Argus*.

Nautilus, owned and operated by Ocean Exploration Trust (OET), is a 64.23 m research vessel, built in 1967 in Germany and refitted as a research ship in 2008 by OET. The ship includes a dynamic positioning system for remaining on site during ROV operations as a stable platform.

ROVs *Hercules* and *Argus* are a dual ROV system that work in tandem to explore the seafloor. *Argus* is deployed with the main .68 cable from the ship and is weighted to keep tension on the wire, absorbing the motion of the ship above and providing stability to *Hercules*. *Argus* has an Insite Pacific Zeus Plus high definition video camera and a series of lights to act as lighting and an eye in the sky for the more close up detailed work. *Hercules* is tethered to *Argus* by a 30 m tether and can sit motionless just above the seabed for detailed imaging and sampling. *Hercules* is equipped with numerous cameras and a changeable sampling toolbox that can be tailored for the mission. This includes two manipulator arms and a suction sampling system.

Hercules has a maximum working depth of 4,000 m and *Argus* can go to 6,000 m. The vehicles are launched from the back deck of *Nautilus* and descend at a 20-30 mpm rate. Once on bottom, *Hercules* has two Mesotech and SeaPrince forward scanning sonars for locating targets on the seabed, which will be key in locating and navigating around the wreck site.

5.3 Site Mapping and Photomosaic

Systematic high resolution imaging is critical for identification, documentation and analysis of submerged cultural sites. Mapping the site to create a hi-res photomosaic is the top priority of the survey. This mapping is expected to take 8 hours, which is the majority of our time on site.

ROV *Hercules* is equipped with a suite of mapping sensors consisting of a pair of stereo cameras, a high resolution multibeam sonar and a structured light laser sensor. These three systems are operated simultaneously and can be co-registered to create hybrid optical and acoustic sea floor reconstructions at cm-scale resolution. The data processing and map making techniques applied to the collected data are based on the Simultaneous Localization and Mapping (SLAM) concept, which provides a mathematical optimization framework for addressing both sensor and vehicle navigation errors related to doppler drift in a self-consistent manner. The resulting maps can then enable the accurate measurements of small features, such as features on amphora handles, and allow for the detection of variations in sediment surrounding an archaeological site. Combining acoustic and visual sensors provides insight into the shape and textural characteristics of the artifacts.

The photomosaic cameras will be downward facing and the ROV will be programmed to run lines with a 30% - 40% overlap. OET will post-process all the imagery and produce 2D and 3D site maps. Two dimensional photomosaics and 3D stereo reconstruction created using the captured images provide a comprehensive visual representation of a site. Additionally, change detection and precise structural measurements can be derived from maps from bathymetry created visually or acoustically using multibeam or structured light data. Photomosaic mapping will not disturb the site in any way.

5.4 Image, Video of Specific Site Features

The second goal of the imaging portion of the survey is to video document the areas including the F9C-2 Sparrowhawk aircraft, in particular biplanes 1 and 2. The biplanes present a mapping challenge due to their structure and site formation process. Three of the biplanes have top wings which are protruding from the seafloor, allowing for hidden structural information without alternate mapping. One of the biplanes is also at a fairly extreme angle in the sediment, possibly due to a collapse (Figure 9). Creating a 3D map will allow for improved documentation and understanding the aircraft deterioration.

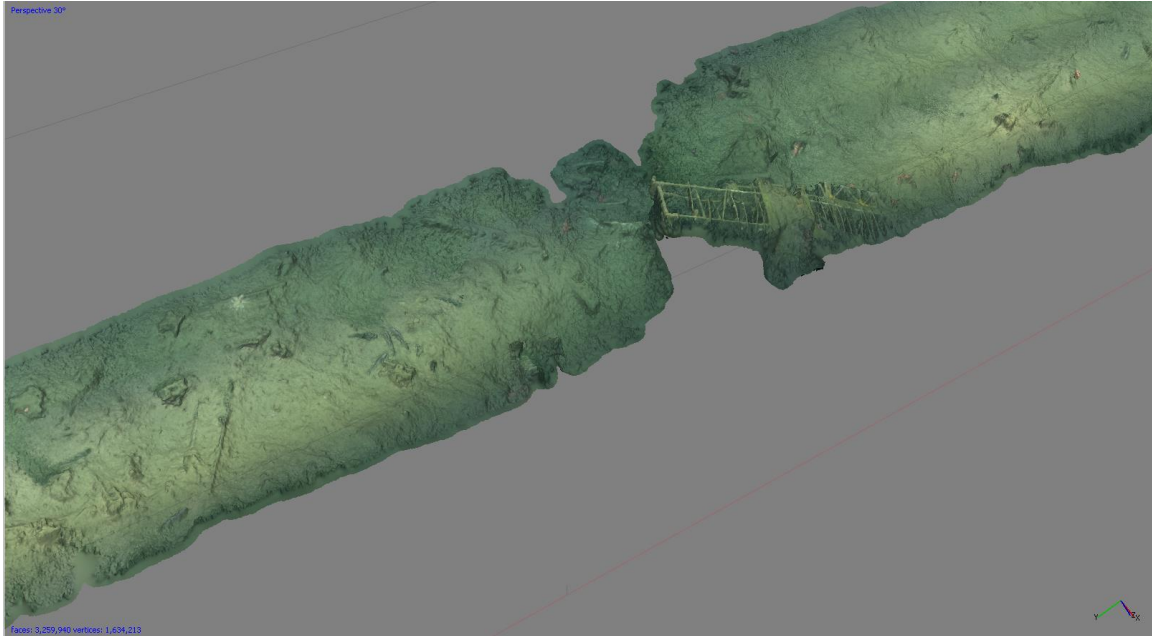

Figure 9- 3D model of biplane 4 and its resting angle. (NOAA, MBARI, Lickliter-Mundon)

The forward-facing HD camera will be used set to a pre-determined tilt, zoom, and color correction setting. The ROV will film the two biplanes in situ in a circular, spiraling movement from bottom to top, then top to bottom in the alternate direction to ensure 80% overlap for all stills in consistent light. If time allows, similar video documentation of the remaining two biplanes and other significant site features will be made. Also, time allowing, we will further investigate features seen on the biplanes or marine life with zoom. This video documentation of site features will not disturb the site in any way.

5.5 Excavation and Artifact Collection

If time allows, we propose limited but invasive excavation of an area 1x1m using the ROV's brush tool. The purpose of the excavation would be to determine the extent of small remains just below the sediment. A secondary purpose would be to discover if anything remains of the monorail track-system that moved the biplanes inside of the hangar. Third, a strategic excavation would allow some idea of whether the raised areas present on site are mounded wreckage or geological features. We propose an area within the remains of the aircraft hangar, but outside safe distance from the aircraft.

We seek to recover one piece of duralumin girder framework from the remains of the airship. This piece will be no longer than 25 inches in length and should not require cutting or breaking. We should be able to source this piece from anywhere on the site and will focus on the outside edges of the debris field, but the recovery will be entirely opportunistic based on our requirements. We will only disturb the area immediately surrounding the sample artifact and likely the only disturbance will be the removal of the artifact.

Macon's girders are the most ubiquitous artifacts at the wreck site (Figure 10). Many are disarticulated and reflect either the violent rending of the ship's structure during the crash or have fallen apart due to decomposition of the rivets. It is difficult to delineate many girder parts because they can barely be seen underneath a fine layer of sediment.



Figure 10- Disarticulated box girder, Field A (NOAA, MBARI 2007)

Artifact collection will occur only if time and safety allow, and at the end of the dive. *Hercules* will be the ROV used for artifact collection. It is fitted with Kraft Predator and ISE Magnum hydraulic manipulators. We will be able to pick up a sample of the aluminum frame relatively easily and should anticipate only to take precautions in the form of rubber or similar contact pads. We will also have need of the brush tool in order to confirm sample size and complete documentation prior to recovery.

Video and still imagery of the artifact, along with georeferenced positioning, will be recorded prior to recovery. The artifact will be placed into *Hercules'* onboard storage container drawers and will return with it to the surface, whereupon it will be transferred to temporary wet storage for transport to NHHC's Underwater Archaeology Branch Conservation Lab at the Naval Yard in Washington, D.C.

5.6 Water Chemistry Data and Corrosion Readings

Water chemistry readings will be taken from the ROV for salinity, temperature, and oxygen levels at depth.

The ROV will carry a Polatrak Deep C Meter 3000 AD bathycorrometer⁴, which is a voltage-reading probe designed for work-class ROV use. Time allowing, we will take readings of biplane aluminum on pieces of the wing that have been disarticulated from the rest of the aircraft. This should take less than one hour and only minimally disturb the site. The probe will not harm the aluminum. Ideally, the readings will be taken from the outermost visible starboard wing rib of biplane 3 (Figure 11).

⁴ Full spec sheet see Appendix B.



Figure 11- Starboard wing of biplane 3, outlined box shows disarticulated rib. (MBARI, NOAA)

6. Artifact Conservation and Curation

The duralumin frame sample will be retrieved from the ROV's storage container and transferred to the ship's wet lab. Limited handling should include photography and a limited conservation assessment. The sample should then be placed in cold storage in saltwater until arrival in San Francisco. The sample will be wrapped in cloth and packed in an insulated container for overnight delivery and should arrive August 20th, 2015 at the conservation facility. The cost of conservation is covered by a private grant and the OceanGate Foundation.⁵

6.1 Artifact Documentation and Conservation

Artifact documentation and conservation will be done at NHHC's Underwater Archaeology Branch Conservation Lab at the Naval Yard in Washington, D.C., by Megan Lickliter-Mundon and monitored by Kate Morrand. Ms. Lickliter-Mundon is a PhD student in the Nautical Archaeology Program at Texas A&M and has completed conservation on a 1991-recovered frame piece of the *Macon* site. Ms. Morrand is UAB's senior conservator and laboratory manager.

The frame piece will be photographed and measured once received in the conservation facility. Prior to treatment the artifact should undergo scanning with an optical and electron microscope and XRF analysis. These tests will allow the identification and documentation of corrosion processes and verification of elemental makeup. Documentation will focus on the degree and depth of pitting on the sample and will note this vs the amount of sediment covering it in-situ. The results will be used to make comparisons to previously documented *Macon* duralumin, which we hope will allow researchers to trace and interpret the rate of decay of the aluminum on site.

⁵ Full conservation budget see Appendix C.

Treatment is citric acid-based and adapted from similar aircraft aluminum projects (Degrigny 2004; Adams 1992). Degrigny's electrolytic method was developed for composite metal artifacts and has been experimented with on large aircraft (Bailey 2004). The portion concerned with aluminum alloys involves mechanical cleaning, electrolytic reduction in a citric acid and sodium hydroxide solution, and application of a protective wax. A recent study (Ryan et al 2013) and Ms. Lickliter-Mundon's 2013 experiment with the 1991-recovered frame piece have seen success with a washing technique in place of electrolytic reduction.

Given the expected relative integrity of the sample and the successful treatment of a sample of the same material the planned conservation treatment is submerging the sample in a .055M solution of citric acid with sodium hydroxide where the pH should be maintained at 5.4. Due to the high risk of re-pitting during processing the solutions and pH will have to be meticulously stirred, maintained, and refreshed. Light scrubbing or use of an air scribe for removal of marine growth will be considered if necessary. Treatment should last until the sample reaches an acceptable level of chloride content, or less than 10 ppm. The sample should be rinsed thoroughly and dried in ethanol, then submerged in BTM. The sample should then be sealed with a microcrystalline renaissance wax.

Conservation treatment is not expected to exceed three months, and all conservation paperwork and a complete report will be provided to NOAA, the US Navy Underwater Archaeology Branch, and the curatorial facility. Should the conservation exceed three months, all schedules will be adjusted accordingly to accommodate.

6.2 Curation

In agreement with the permitting rules of the NHHHC the artifact will be curated on a long-term loan basis at a responsible organization. The conserved artifact is proposed to be loaned to the National Air and Space Museum, Udvar Hazy facility, to be displayed in the Lighter-than-air exhibit that currently complements the FC9-2 Sparrowhawk aircraft.

7. Public Outreach, Educational Opportunities and Partnerships

The education and outreach vision for this project is to promote understanding, and appreciation of the USS *Macon* and its four Curtis Sparrowhawk F-9C-2 aircraft located in Monterey Bay National Marine Sanctuary, as well as highlighting NOAA's National Marine Sanctuary Program and Maritime Heritage Program's role in surveying, managing and protecting archaeological sites; thereby empowering the public to make informed decisions on responsible stewardship of natural and cultural resources.

Pre-Mission Products Media and Outreach

In advance of media interest in the 2015 Mapping Survey and Conservation Assessment of the USS *Macon* Site expedition, ONMS will prepare a two-page fact sheet highlighting the history of the USS *Macon*, past expeditions to the site and current mission goals working with The Ocean Exploration Trust (OET), OceanGate Foundation and U.S. Navy. ONMS will make available pre-mission, high-resolution historic still images with caption and credits of the USS *Macon*, Curtis Sparrowhawk F-9C-2 aircraft, U.S. Navy crewmen that served on board the airship, as well as historic video b-roll footage of the airship in flight.

The outreach goals are to highlight not the only history of the USS *Macon* and its four biplanes, but the current technology being applied by OET and NOAA to continue to conduct archaeological surveys over time, monitor change, and the continued protection and management of the historic remains of this unique wreck site. Outreach messaging will also focus on commemorating the 80th year anniversary since the loss of the USS *Macon* and two of her navy sailors. OET's Exploration Vessel (E/V) *Nautilus*, with her associated technologies, and shore-based facilities at the University of Rhode Island (URI) — including the Graduate School of Oceanography (GSO) and the Inner Space Center (ISC) — will enable students, the academic community, and the public worldwide to experience and participate in the expedition in real time. ONMS will prepare visual outreach messaging products to provide information for the upcoming mission that can be shared through NOAA, NOS, ONMS and MBNMS' social media; Facebook, Twitter, and YouTube and be linked to OET to reach a broader audience.

OET Goals and *Nautilus* Capabilities

The Ocean Exploration Trust (OET) utilizes research from Exploration Vessel (E/V) *Nautilus*, her associated technologies, and shore-based facilities at the University of Rhode Island (URI) — including the Graduate School of Oceanography (GSO) and the Inner Space Center (ISC) — to enable students, the academic community, and the public worldwide to experience and participate in the expedition in real time. In addition to educational programs, OET employs an extensive outreach program via digital platforms and traditional media, bringing awareness of our research and expeditions to the public through live streaming video and interactions with scientists and engineers from the ship 24-hours-a-day via the *Nautilus* Live website (www.Nautiluslive.org). OET's outreach efforts broaden the audiences of research launched from E/V *Nautilus* to millions worldwide each year and allow the public, students, and scientists to participate in expeditions virtually from shore.

The telepresence technology installed on E/V *Nautilus* allows the public to engage in a unique two-way dialogue with onboard team members connecting directly with onshore audiences through special programming at venues such as universities, museums, and science centers. Another key engagement point for students and the public is the "Send a Question" feature on the *Nautilus* Live website. Questions submitted by onshore viewers were answered over the audio accompanying the live streaming video feed. This format also allowed the public to play a role in the identification of archaeological and biological discoveries throughout the expedition season, creating a crowdsourced participatory experience that encouraged the public to dive deeper into the content and research being done onboard.

The Inner Space Center (ISC) at the University of Rhode Island Graduate School of Oceanography is the technical facility that supports all telepresence-related activities for E/V *Nautilus*. The primary requirement for establishing ship-to-shore telepresence activities is a high bandwidth Internet connection that is usually satellite based. The ISC represents the telepresence hub for receiving, recording, and redistributing all streaming video, audio, and data, in addition to being the hub through which remote user participation occurs. The telepresence paradigm involves live interactive involvement by shore-based participants in the active ship-based exploration program. Shore participation takes many forms including, but not limited to, remote scientific decision making and leadership, scientific data transfers for near real-time processing, logging of scientific observations through online voice communications and instant messaging, delivery of interactive educational programming with live audiences, and remote participation by vast audiences through hosted web sites.

8. Products

A research report will be completed discussing the archaeological remains of the USS *Macon* and four Curtis F9C-2 Sparrowhawk aircraft. The report will include a description of the physical setting of the site, history of the airship and aircraft, field methodology, education and outreach components, and a summary of the survey. The report will also include the conservation process and outcome of the sample frame, the results and interpretations of the analysis, the data from the corrosion readings taken on site, and recommendation for in-situ preservation and site management, as well as recommendations for further research.

NOAA will send out media press releases focusing on the results of the mission, partnerships, updated fact sheet and still and video imagery captured during the 2015 Mapping Survey and Conservation Assessment of the USS *Macon* Site expedition

OceanGate Foundation will host a series of webinars with mission scientists following up the conservation of artifacts.

Data collected from *Nautilus* expeditions are automatically archived at the Inner Space Center (ISC) at the University of Rhode Island's Graduate School of Oceanography (GSO). A full copy of the data collected will be provided on a hard drive for the lead scientist, and a copy of the video can be requested after quality control and archiving at ISC. Photomosaic and bathymetric maps will be prepared by the Roman lab at GSO.

Detailed video/still documentation of site features will be used to determine contextual relationship of artifacts, to determine identity of objects and to assess condition of remains. Images will be used to compare with 1990/91 and 2006 images to assess possible deterioration of aluminum structure. Sediment levels and item location surrounding the two biplanes will also be assessed.

If possible, a 3D model will be created by NOAA efforts from the video taken around the two biplanes. The model will be primarily for use in public outreach efforts but might also be used to complement the display of the conserved girder piece at NASM.

Publications and presentations will be encouraged by all parties for scientific and public audiences.

9. References Cited

Adams, Christopher D.

1992 The Treatment of the BMW 801D-2 Radial Aero Engine Rescued from the Loiret River. Australian War Memorial, Canberra, Australia.

Bailey, G.

2004 Stabilization of a Wrecked and Corroded Aluminum Aircraft. *Metal 04: Proceedings of the International Conference on Metals Conservation*, John Ashton and David Hallam, editors, pp. 453-464. National Museum of Australia, Canberra, Australia.

Degrigny, C.

2004 Development of an Electrolytic Stabilisation Method, for Aluminium Alloy Remains from Aircraft Wrecks. Broken Wings <http://202.14.152.30/collections/maritime/march/fallenangels/bv222.html>.

Dick, Harold G. and Douglas H. Robinson

1985 *The Golden Agent of the Great Passenger Airships Graf Zeppelin & Hindenburg*. Smithsonian Institution Press, Washington, D.C. pp. 172 – 182.

Grech, C.

2007 Rediscovery of Airship USS *Macon*: The First Archaeological Survey within the Boundaries of the Monterey Bay National Marine Sanctuary. *Oceans 2007: On the Edge of Tomorrow*, pp. 1–10. Marine Technology Society, Vancouver, BC.

Grossnick, Roy A. (editor)

1987 *Kite Balloons to Airships: The Navy's Lighter Than Air Experience*. Published by the Deputy Chief of Naval Operations (Air Warfare) and the Commander, Naval Air Systems Command, Washington, D.C., GPO, pp. 23-34.

Milbrooke, A., P. Andrus, J. Cook, and D. Whipple

1998 *Guidelines for Evaluating and Documenting Historic Aviation Properties*. US Department of the Interior, National Park Service, National Register of Historic Places.

Miller, Harold B.

1995 The Reminiscences of Rear Admiral Harold B. Miller, U.S. Navy (Retired). Manuscript, Interviewed by Dr. John T. Mason, Jr. U.S. Naval Institute, Annapolis.

Robinson, Douglas and Charles L. Keller

1982 *Up Ship!: A History of the U.S. Navy's Rigid Airships 1919 - 1935*. Naval Institute Press, Annapolis.

Ryan, M., B. Moorhouse and A. Cruickshank

2013 Dornier Metallurgy and Restoration. Report for RAF Cosford Conservation Team. Imperial College London.

Smith, Richard K

1965 *The Airships Akron and Macon: Flying Aircraft Carriers of the United States Navy*. Naval Institute Press, Annapolis.

Vaeth, J. G.

1992 U.S.S. *Macon*: Lost and Found. *National Geographic* (1): 114–127.

Williamson, Lew "Woody"

[1930s] Papers of Lew Williamson, Operational Archives Branch, Naval Historical Center, Washington, D.C.

Appendix A- Equipment Specifications

Exploration Vessel *Nautilus*

E/V Nautilus is a 64-meter exploration vessel with 17 permanent crew and berthing for a 31-member rotating Corps of Exploration. The ship carries with it two Remotely Operated Vehicles (ROVs) named *Hercules* and *Argus* that explore the seafloor in real-time online via our telepresence technology. A new hulled-mounted multibeam system will be installed this winter. The ship also has a Data Lab and Wet Lab for processing digital data and physical samples. As part of our effort to share our expeditions with students and colleagues, we stream video from our ROVs and various locations on the ship live on our Nautilus Live website.



Specifications

Length 64.23 meters (211 feet)

Beam 10.5 meters (34.5 feet)

Draft 4.9 meters (14.75 feet)

Tonnage 1249 gross, 374 net

Main Propulsion Single 1286 kw (1700 HP), controllable pitch

Speed 10 knots service, 12 knots maximum

Endurance 40 days

Range 24,000 kilometers (13,000 nautical miles)

Dynamic Positioning 300kW azimuthing jet-pump (stern), 250kW tunnel (bow)

Classification Germanischer Lloyd (GL) 100 A5 E1 (Ice Strengthened)

Built 1967, Rostock, E. Germany

Formerly Alexander von Humboldt (East German research vessel)

Berthing 48 persons (17 crew; 31 science/operations)

Flag St Vincent and the Grenadines

Home port Bodrum, Turkey

Communication Broadcast C-band satellite communications, 18 mbps (HD video)

Call sign J8B3605

Deck Equipment A-frame, 6-ton capacity; Knuckle-boom crane, 4.2-ton capacity with 2 extensions; Dynacon 421 oceanographic winch, 8.8-ton capacity with 4300m 0.68" cable; Hatlapa oceanographic winch, 2.1-ton capacity with 3000m 0.322" cable

Remotely Operated Vehicles (ROVs)

E/V *Nautilus* has two shipboard remotely operated vehicles (ROVs) named *Hercules* and *Argus* that work in tandem. This system is a state-of-the-art deep-sea robotic laboratory capable of exploring depths up to 4,000 meters. Each of the ROVs has its own suite of cameras and sensors that receive electrical power from the surface through a fiber-optic cable, which also transmits data and video. Engineers and scientists control the vehicles from a control room aboard *Nautilus*, with some dives lasting more than three days. The system is a versatile tool capable of supporting a wide range of oceanographic instrumentation and sampling equipment. They have surveyed ancient shipwrecks, discovered hydrothermal vents, and explored habitats in oceans and seas around the world.



ROV *Hercules*

Since it was first launched in 2003, *Hercules* has been working in tandem with *Argus* to explore the geology, biology, archaeology, and chemistry of the deep sea. *Hercules* is equipped with a high-definition video camera, four HMI lights, two manipulator arms, and a variety of oceanographic sensors and samplers, including a suite of high-resolution mapping tools. *Hercules* weighs about 5,200 lbs in air and can deliver approx. 150 lbs of samples or tools to and from the seafloor.

ROV *Hercules* Specifications

Standard Configuration

Depth Rating 4,000 meters (13,123 feet)

Air Weight 2400 kg (5200 lbs)

Video 1x 3-chip High Definition cameras w/zoom, pan & tilt

1x Standard Definition pan & tilt camera

5x Standard Definition cameras

1x stereo high-resolution still-camera system

Lighting 4x 400W HMI, 2x 250W incandescent

Navigation Tracklink 5000 USBL acoustic position RDI acoustic Doppler velocimeter (600 & 1200 kHz); Ixsea OCTANS gyro; DVLNAV navigation software

Manipulators Kraft Predator, ISE Magnum 7-function

Sonars Mesotech 1071 series profiling sonar (300 kHz)

Imagenex 881A profiling sonar (600 kHz)

Tritech Super SeaPrince profiling sonar (600 kHz)

Sensors Sea-Bird FastCAT 49 CTD

Aanderaa optode

WHOI high-temperature probe

Sampling Tools Suction sampling system: 2x 8-liter acrylic buckets

“Snuffler” jet-suction excavation system

Suction-cup artifact recovery tool

2x sample bays, configurable with sealed biological boxes

Geologic boxes, various crates and containers

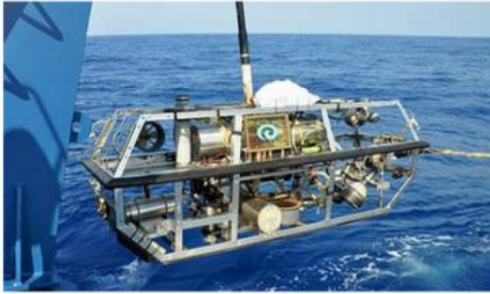

ROV *Argus*

Argus was first launched in 2000 as a deep-tow system capable of diving as deep as 6000 meters. *Argus* is now typically used in tandem with *Hercules*, where it hovers several meters above in order to provide a bird's-eye view of *Hercules* on the seafloor. It is also capable of working as a stand-alone system as a towed-body instrument for large-scale deepwater survey missions. Sidescan sonar looks out on either side of the vehicle up to 400 meters total swath.

ROV *Argus* Specifications

Depth Rating 6,000 meters (currently limited to 4,000 meters by cable length)

Air Weight 1800 kg (4000 lbs)

Video 1x High Definition w/ zoom & tilt, 3x SD cameras

Lighting 2x 1200W HMI, 2x incandescent

Sonars Mesotech 1071 series profiling sonar (600 kHz)
Tritech SeaKing subbottom profiler (20/200 kHz)
Edgetech 4200 HF sidescan sonar (300/500 kHz)

Data Products

Seafloor Mapping

Multibeam echosounder |

Xbt profiles

- Sound speed velocity profiles
- Raw datagram
- Gridded multibeam bathymetry
- Backscatter mosaic
- Water column analysis

Sub-bottom profiler | knudsen raw or xtf data files

Sidescan sonar | jsf raw data files

Hercules Operations

Imaging | high definition video from *hercules* main camera, still captures from hd video

Navigation | vessel lat/lon, vessel heading, vehicle lat/lon, vehicle heading, vehicle attitude, doppler velocity log

Sensor data | ctd, o2, depth, altitude, temperature probe

Acoustic data | seaking forward-looking sonar raw data files

Samples | sampling may include grab samples, push cores, niskin water samples

Operational logs | eventlog, dive reports, sample logs

Precision seafloor mapping |

- Stereo imagery, bathymetry
- High freq multibeam
- Laser mapping

Argus Operations

Imaging | high definition video from *argus* main camera, still captures from hd video

Navigation | vessel lat/lon, vessel heading, vehicle lat/lon, vehicle heading, vehicle attitude

Sensor data | depth, altitude

Acoustic data |

- Seaprince sub-bottom profiler raw data files
- Edgetech sidescan sonar raw jsf (by advance request)

Operational logs | eventlog, dive reports

Technical datasheet

Polatrak Deep C Meter™ 3000 AD

General

The Polatrak Deep-C-Meter 3000 AD is designed for rugged service on a work-or-inspection class ROV. The unit is ROV powered and provides continuous visual and digital output. Rated for operation in up to 10,000 feet (3000 m) depth, this system can be used for any inspection. The instrument readout unit can be conveniently mounted anywhere on the ROV, and the probe unit is held in the tee-handle manipulator mount. The Deep C Meter kit includes an ROV-II probe, an articulated mount, standard whips and all standard replacement parts.

Specifications

Depth rating	10,000 ft [3,000 m]
Operating temp.	1°C to 55°C
Voltage range	+2499 mV to -2499 mV
Input resistance	1 G-Ohm
Power supply	24VDC nominal (9-36VDC)
Communication protocol	RS 232
Data type	Continuous ASCII stream with delimiters 2 data sets per second
Precision	24 bit analogue digital converter

Electrode elements*

ROV-II has two electrode elements which are interchangeable to suit specific water environments

Ag/AgCl (Silver/silver chloride)

Material	Ag/AgCl with Silver Wire Core
Dimensions	Ø 0.3" x 1.8" [Ø 8 mm x 45 mm]
Accuracy	± 5 mV
Applications	Seawater

Cu/CuSO4 (Copper/copper sulphate)

Material	Cu/CuSO4 with copper wire core
Dimensions	Ø 0.3" x 1.4" [Ø 8 mm x 36 mm]
Accuracy	± 5 mV
Applications	Fresh water / Slightly brackish water

*Ag/AgCl elements provided as standard

Standard kit components

Offshore storm case, Deep C Meter 3000 AD, ROV-II probe, Zn calibration coupon, spare electrode, tips and o-rings. Additional spares and replacements are available upon request.

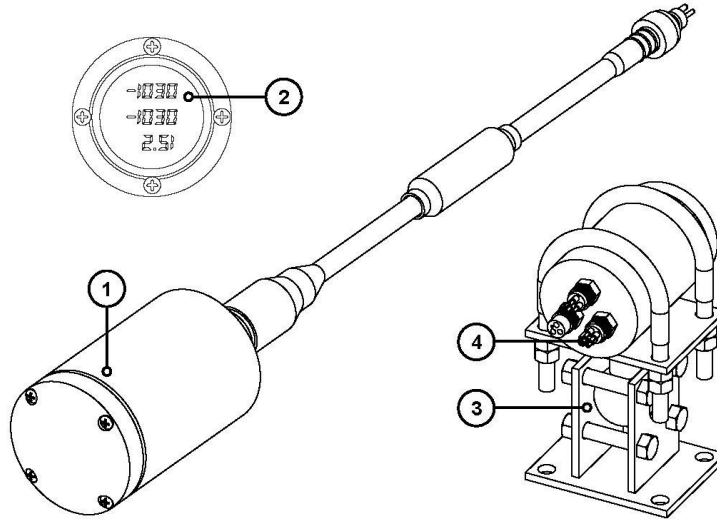

Overall weights & dimensions

Deep C Meter AD

Dimensions (Ø x L)	Ø 3.5" x 7" [89 x 178 mm]
Weight (Air)	9 lb [4 kg]
Weight (Water)	8 lb [3.6 kg]

Main body

Pressure housing (Item 1)

Material	316 stainless steel
Internal components	LED readouts

Lens assembly (Item 2)

Material	Clear acrylic
Dimensions	Ø 3.5" x 0.9" [Ø 89 mm x 23 mm]
Seal	2 No. O-rings, 1 No. B/U ring
Fixings	4 No. SS316 retaining screws
Display	3 No. 4 digit 0.4" [10 mm] ultra bright blue LED display

Meter mount (Item 3)

Material	316 SS
----------	--------

Pin interface (Item 4)

Power bulkhead Micro WET CON MCBH 4M

Pin 1 +24VDC	Pin 3 TX (RS 232)
Pin 2 -0VDC digital ground	Pin 4 RX (RS 232)

Offshore transit case

Dimensions (W x H x D)	25" x 20" x 12" [635 x 508 x 305 mm]
Packed weight	45 lb [9.5 kg]

ROV-II contact tip (Item 5)

Material	Stainless Steel 316 pointed tip
Dimensions	60° point, 0.75" [19 mm] long, 0.38" [10 mm] A/F
Features	Fully replaceable

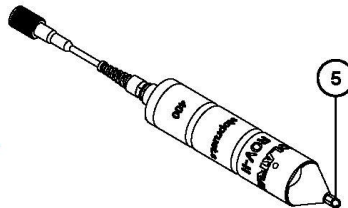

Appendix B- Artifact Conservation Budget

USS Macon Survey & Artifact Conservation Budget

						Total
Survey Days						
Airfare to/from Seattle	OET Booked	\$ 307.20	for	1	ticket(s)	\$ 307.20
Hotels x2 (LA/San Fran)	OET Books	\$ 110.00	for	2	night(s) estimate	\$ 220.00
Contractor Fees	Megan Macon Day	\$ 40.00	for	12	hour(s)	\$ 480.00
Contractor Fees	Megan non-Macon days	\$ 180.00	for	9	day(s)	\$ 1,620.00
Contractor Fees	Initial Artifact Doc & Trans	\$ 40.00	for	5	hour(s)	\$ 200.00
Special Equipment	Ecorr and ship	\$ 115.00	for	12	day(s)	\$ 1,380.00
Conservation & Analysis						
Artifact Transport	Fed Ex & Container	\$ 150.00	for		estimated	\$ 150.00
Materials	Chemicals, Meters	\$ 150.00	for		estimated	\$ 150.00
Special Analysis	SET, Shipping	\$ 500.00	for		estimated	\$ 500.00
Megan Airfare	2x trips	\$ 500.00	for	2	ticket(s) estimated	\$ 1,000.00
Megan Hotel	pre-arranged, no cost	\$ -	for	12	day(s)	\$ -
Contractor Fees Conservation	Estimated hours	\$ 40.00	for	90	hour(s)	\$ 3,600.00
Expenses- DC	Metro, Cab, per diem	\$ 800.00	for		estimated	\$ 800.00
Report Write Up		\$ 40.00	for	8	hour(s)	\$ 320.00
Admin/ Post Processing						
Survey Proposal/Liaise	Write-up, emails	\$ 40.00	for	20	hour(s)	\$ 800.00
Mapping Process Cost	OET team	\$ 4,000.00	for	1	week	\$ 4,000.00
3D Modeling Bi-Plane		\$ 40.00	for	12	hour(s)	\$ 480.00
Funding						
Matthews Foundation/Ocean Gate						\$ 15,000.00
Sanctuaries Foundation						\$ 1,000.00
Total cost of the trip						\$ 16,007.20
##						\$ 7.20